

特記

受領

製図年月日

製図

営業

工事

工事名

図面番号

施工

殿

製品名

網戸付き可動ルーバー面格子
ツバーサUT(内倒し窓)：レバー位置

レバー1

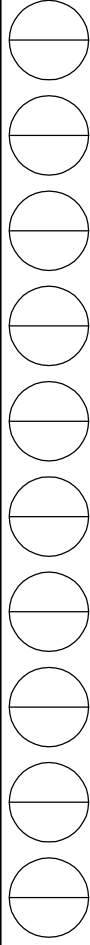
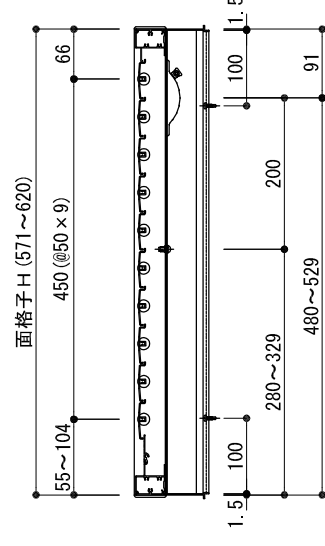
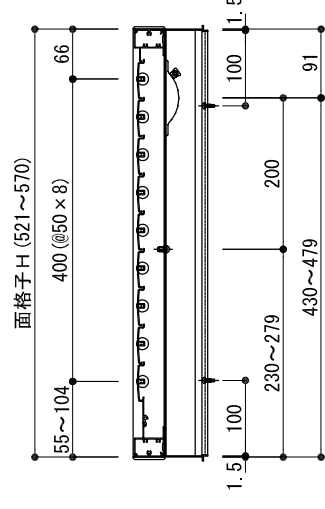
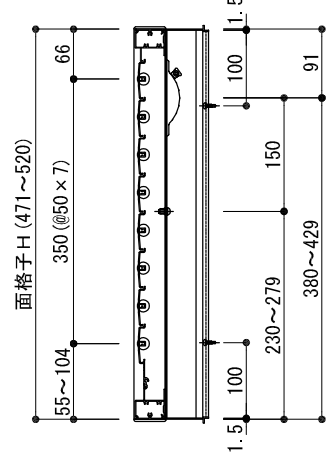
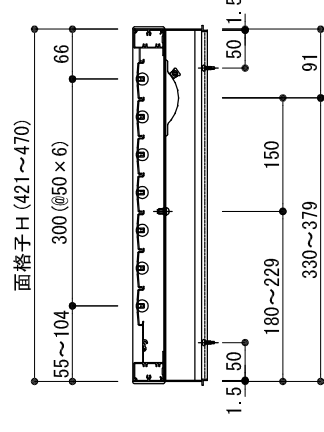
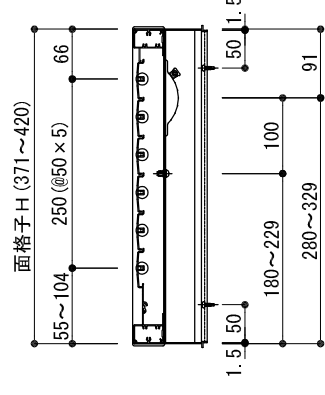
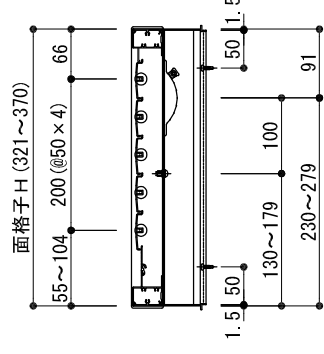
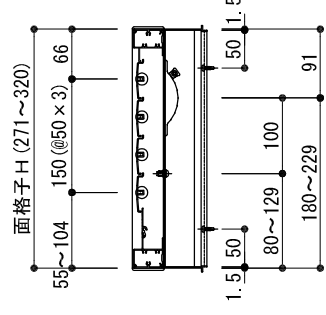
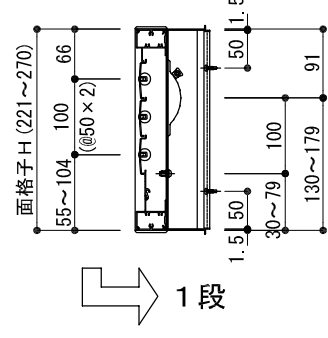
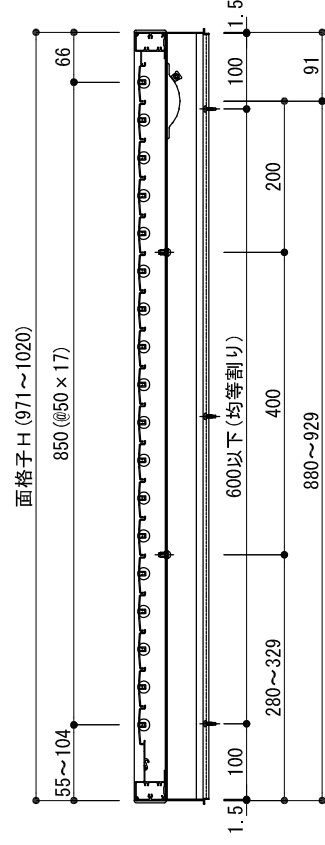
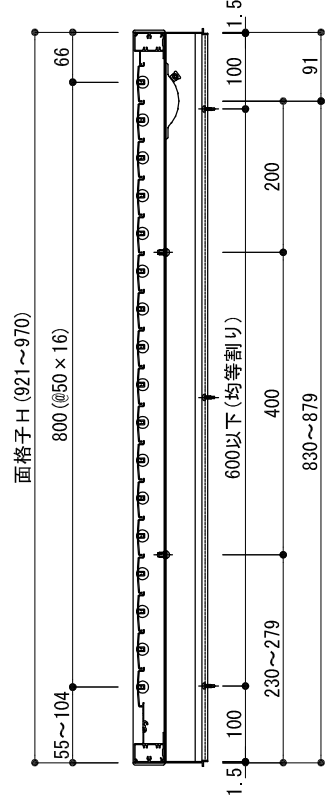
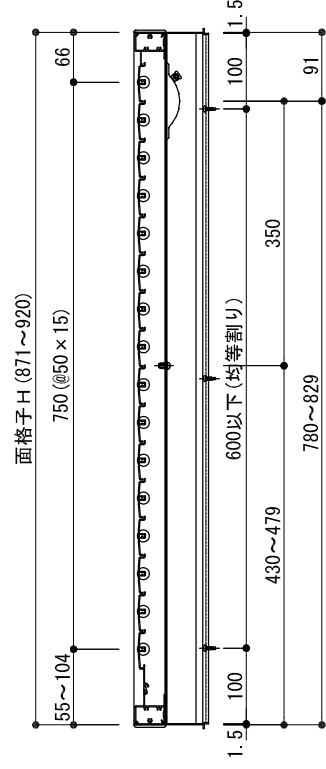
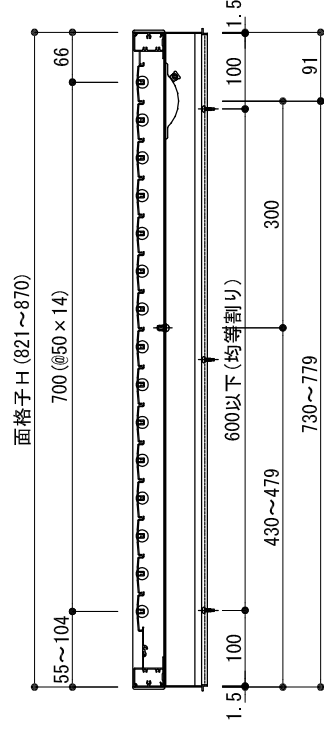
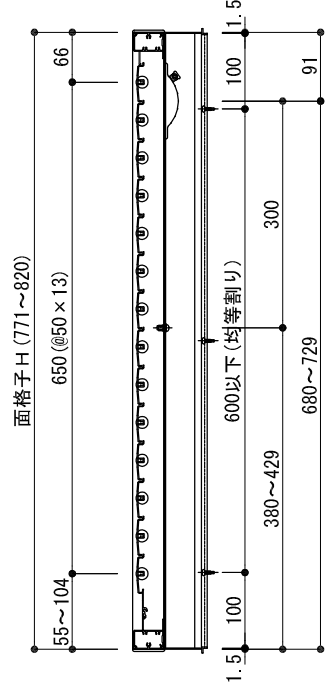
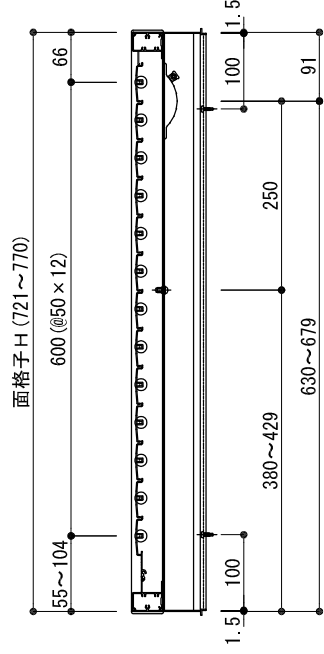
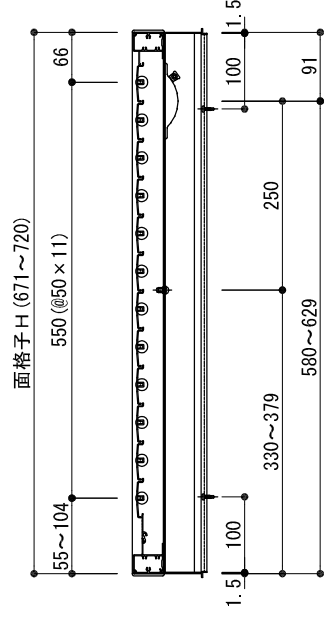
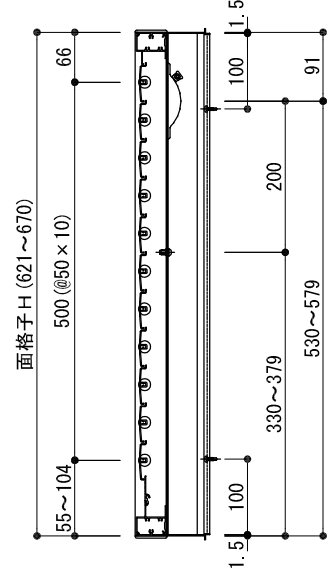

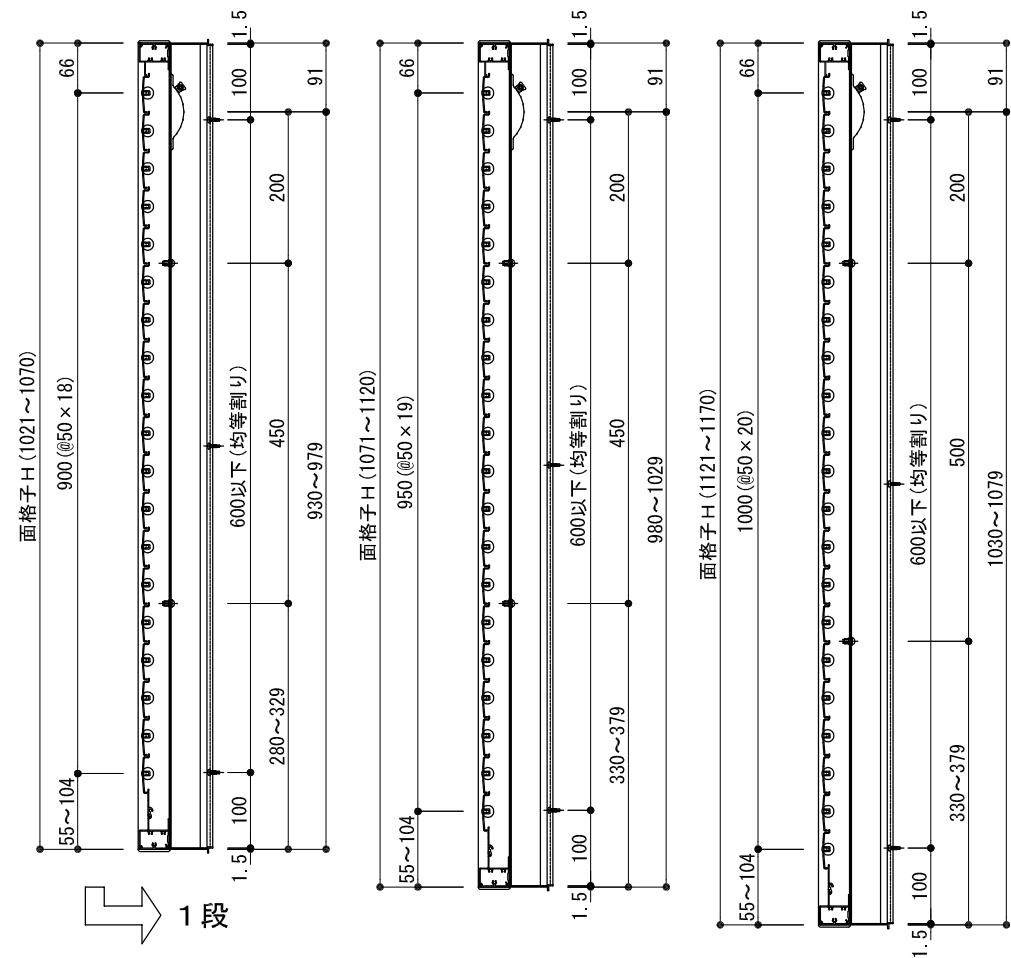

【ビス位置基準】

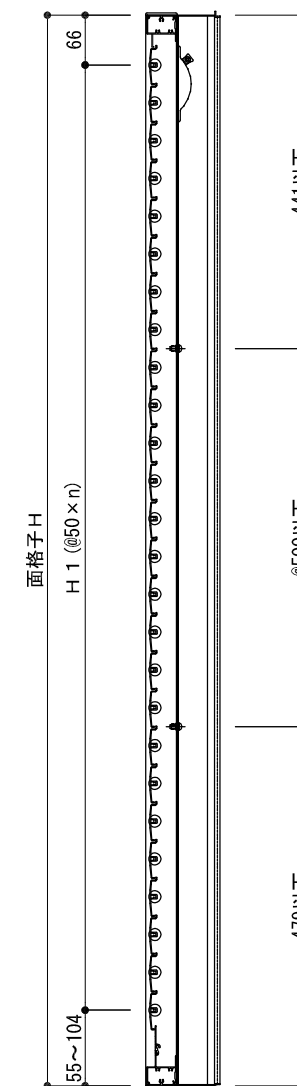

【各サッシメーカー別内倒し窓製作H寸法表】

サッシメーカー	サッシ最小H	最小面格子H	サッシ最大H	最大面格子H
LIXIL(トステム):PRO-SE	300	347	1000	1047
YKKAP:EXIMA31	300	345	1000	1045
YKKAP:EXIMA31 2段階オプション仕様	380	425	1000	1045
不二サッシ:FP-AT70、AT70P	300	322	1100	1122
三協立山アルミ:MTG-70	270	267	1000	997
三協立山アルミ:MTG-70 MS	300	347	800	847
LIXIL(新日軽):RMG-70AT	300	320	1100	1120

※面格子製作範囲H寸法は、H=221(羽根枚数:3枚)~H=1170(羽根枚数:21枚)とする。

